

JUMO GmbH & Co. KG
 Delivery address: Mackenrodtstraße 14
 36039 Fulda, Germany
 Postal address: 36035 Fulda, Germany
 Phone: +49 661 6003-0
 Fax: +49 661 6003-607
 Email: mail@jumo.net
 Internet: www.jumo.net

JUMO Instrument Co. Ltd.
 JUMO House
 Temple Bank, Riverway
 Harlow, Essex CM 20 2DY, UK
 Phone: +44 1279 63 55 33
 Fax: +44 1279 62 50 29
 Email: sales@jumo.co.uk
 Internet: www.jumo.co.uk

JUMO Process Control, Inc.
 6733 Myers Road
 East Syracuse, NY 13057, USA
 Phone: +1 315 437 5866
 Fax: +1 315 437 5860
 Email: info.us@jumo.net
 Internet: www.jumousa.com



JUMO LOGOSCREEN 600

Paperless Recorder with Touchscreen

Brief description

The JUMO LOGOSCREEN 600 paperless recorder features a resistive touchscreen and an intuitive, icon-based operation and visualization concept that makes it very easy to use.

There are different versions of the JUMO LOGOSCREEN 600 available for process data recording. These range from the device version without measuring input in which up to 24 process values are read (master) or received (slave) from external systems via Modbus, through to a device version with six measuring inputs (universal analog inputs), two analog outputs, 12 digital inputs, and 12 individually switchable digital inputs/outputs.

The JUMO LOGOSCREEN 600 can display data using the default visualizations, such as curve diagram (vertical or horizontal), bar graph, text image (numerical), or digital diagram. For batch-related processes a special batch recording is available which allows the storage of additional information. In addition, users can create up to six individual process screens with up to 100 objects per process screen to fit their requirements using the setup program.

High-performance PC programs are available to evaluate archived data.

In addition to the setup program which enables time-saving startup and documentation on the PC, there are two high-performance PC programs for read-out, archiving and evaluation of process data (PCC and PCA3000).



Type 706520/ ...

Block diagram

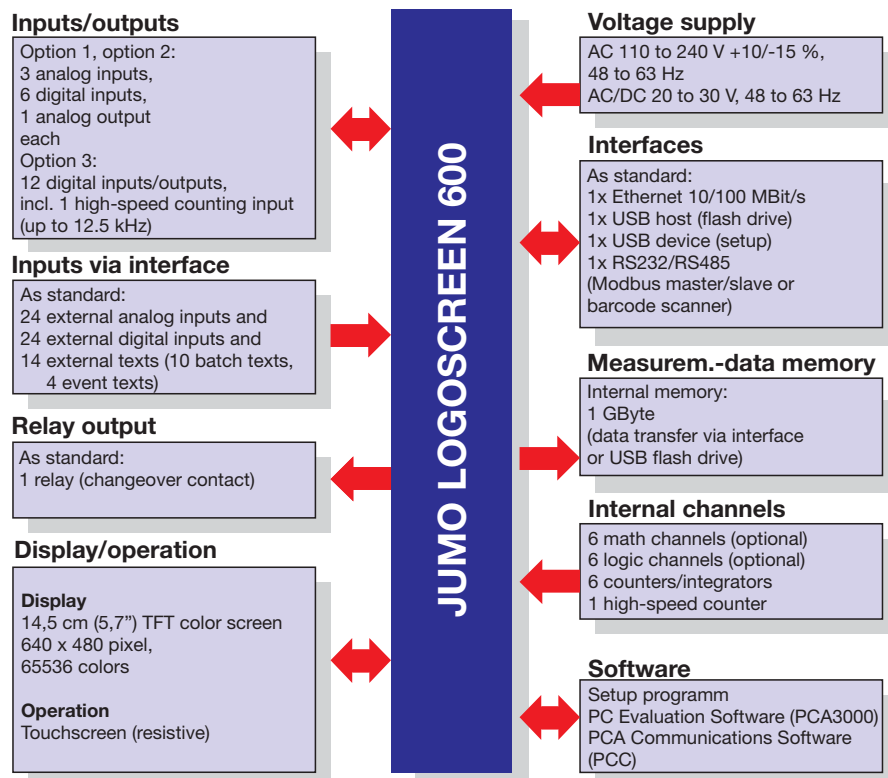

Special features

- Intuitive touch operation
- Brilliant TFT touchscreen (640 × 480, 65536 colors)
- 1 GByte internal data memory
- Up to two analog outputs
- 24 external analog and digital channels via all interfaces (Modbus master/slave)
- Horizontal and vertical line graph
- Up to six customer-specific process screens
- Ethernet interface (standard)
- Integrated web server for online-visualization like at the device
- Batch report recording
- Batch control (start, stop, and texts) even via barcode scanner and interface
- Modbus master function (even with Modbus/TCP)
- Counters and integrators (six channels)
- Math and logic module (six channels each) as extra code
- Counter input (up to 12.5 kHz)
- Automatic data read-out via PCA Communication Software PCC

Approvals/approval marks (see "Technical data")



JUMO GmbH & Co. KG
 Delivery address: Mackenrodtstraße 14
 36039 Fulda, Germany
 Postal address: 36035 Fulda, Germany
 Phone: +49 661 6003-0
 Fax: +49 661 6003-607
 Email: mail@jumo.net
 Internet: www.jumo.net

JUMO Instrument Co. Ltd.
 JUMO House
 Temple Bank, Riverway
 Harlow, Essex CM 20 2DY, UK
 Phone: +44 1279 63 55 33
 Fax: +44 1279 62 50 29
 Email: sales@jumo.co.uk
 Internet: www.jumo.co.uk

JUMO Process Control, Inc.
 6733 Myers Road
 East Syracuse, NY 13057, USA
 Phone: +1 315 437 5866
 Fax: +1 315 437 5860
 Email: info.us@jumo.net
 Internet: www.jumousa.com



Description

Configuration and operation

On the device

Thanks to the JUMO operation and visualization concept, users can use the paperless recorder almost intuitively. All operations are performed on the resistive touchscreen via a menu system which is based on symbols.

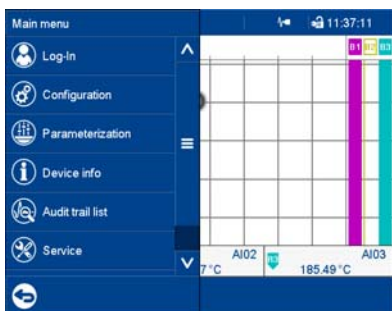

The integrated user administration protects the paperless recorder against unauthorized access. Up to five users with varying access rights can be managed.

With the setup program

The paperless recorder can also be configured using the setup program. It should be noted that some functions are only available in the setup program, such as:

- Changing the operating language
- Assigning user rights
- Creating texts for batch reports
- Creating process screens

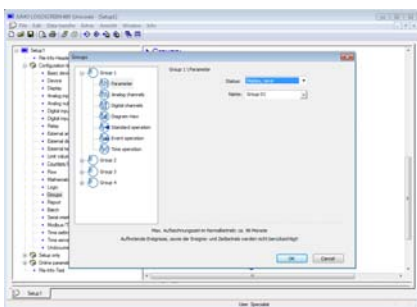

The setup program is installed on a PC with a Windows operating system (7/8/10 – 32 or 64 Bit) and communicates with the paperless recorder via USB or Ethernet interface. It is also possible to transfer configuration files to the paperless recorder using a USB memory stick.

The user can store the configuration data as a file, which can also be printed out for documentation purposes.

Operating language

Several operating languages can be selected on the device. The operating languages can be edited and switched using the setup program. The languages German, English, French, and Spanish are currently available.

Users can also create their own language versions (Unicode-compatible).

Process screen editor

Users can use the setup program to create six individual process screens, which they can subsequently transfer to the paperless recorder and use to display process data. A process screen can consist of up to 100 objects (images, analog channels, digital channels, text, etc.).

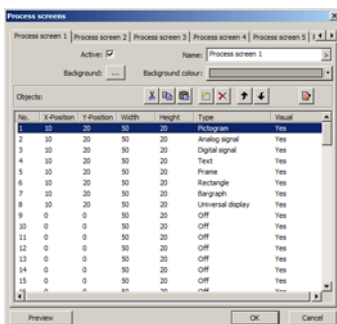

Interfaces

USB

The paperless recorder is equipped with two USB interfaces as standard. A USB memory stick can be connected to the host interface located on the front. The device interface on the back (Micro-B type) can be used to connect the device to a PC (setup program or PCC/PCA3000).

The USB host interface has a cover so that the front of the device complies with protection type IP65.

Ethernet

The paperless recorder is equipped with an Ethernet interface as standard which supports the following functions:

- Communication with a PC (setup program, web server, data archiving with PCC/PCA3000)
- Transmission of emails via an SMTP server
- Time synchronization by an SNTP server
- Communication with a Modbus master/slave

The IP address is either configured as a fixed address or received automatically from a DHCP server; DNS is supported.

RS232/RS485

This standard interface can be configured as RS232 or RS485. It is used for communication with a Modbus master or Modbus slave. It can also be used to connect a barcode scanner.

External inputs via interface

The paperless recorder can access 24 external analog inputs and 24 external digital inputs via the interfaces (Ethernet, RS232/RS485). In addition, 10 texts for batch reports and four event texts can be transferred.

Inputs and outputs

The different device versions of the paperless recorder are available with analog and digital inputs and outputs (options).

The analog inputs (max. 6) are universal measuring inputs for RTD temperature probes, thermocouples, resistance transmitters, resistance/potentiometers, and standard signals (current, voltage).

The analog outputs (max. 2) can each be used as voltage output (0 to 10 V) or current output (0/4 to 20 mA).

The digital inputs (max. 12) and the individually switchable digital inputs/outputs (12) are operated with a voltage of DC 0/24 V.

All device versions feature a relay output with changeover contact.

Data recording

The measured values are recorded continuously with a sampling rate of 125 ms. The report creation and limit value monitoring is performed based on these measured values. The measured values are transferred to the working memory of the device depending on the programmable memory cycle and memory value (current value, average value, maximum value, minimum value, or minimum/maximum values). The paperless recorder stores the data according to group; one input can be assigned to multiple groups (max. 4).

Working memory (SRAM)

The data stored in the SRAM is copied to the internal memory in 20 kByte blocks at regular intervals.

Internal memory (flash)

Whenever a saving block in the working memory is full, it is copied to the internal memory. The internal memory has a maximum capacity of 1 GByte. Each write operation is monitored to ensure that any data storage faults are detected immediately.

The device monitors the capacity of the internal memory and, if the remaining capacity falls below the configured minimum, a memory alarm signal is triggered. This can actuate the alarm relay, for example.

The data is written to the memory as a ring buffer, which means that when the memory is full, the oldest data is automatically overwritten with the new data.

To show the history, data from the internal memory can be displayed on the paperless recorder (history memory: 8 MByte).

Data transfer to PC

Data can be transferred from the paperless recorder to a PC via a USB memory stick or via one of the interfaces (USB device, Ethernet).

Data security

Data is stored in an encrypted format developed by JUMO. This ensures a high level of data security.

JUMO GmbH & Co. KG
 Delivery address: Mackenrodtstraße 14
 36039 Fulda, Germany
 Postal address: 36035 Fulda, Germany
 Phone: +49 661 6003-0
 Fax: +49 661 6003-607
 Email: mail@jumo.net
 Internet: www.jumo.net

JUMO Instrument Co. Ltd.
 JUMO House
 Temple Bank, Riverway
 Harlow, Essex CM 20 2DY, UK
 Phone: +44 1279 63 55 33
 Fax: +44 1279 62 50 29
 Email: sales@jumo.co.uk
 Internet: www.jumo.co.uk

JUMO Process Control, Inc.
 6733 Myers Road
 East Syracuse, NY 13057, USA
 Phone: +1 315 437 5866
 Fax: +1 315 437 5860
 Email: info.us@jumo.net
 Internet: www.jumousa.com



The following applies if the paperless recorder is disconnected from the voltage supply:

- Measurement data in the working memory and time are buffered by a lithium battery (operating life > 7 years).
- If the lithium battery is discharged, the measurement data in the working memory and the time are lost. For the purposes of a battery change, the data is buffered for approximately 6 minutes by a storage capacitor.
- Measurement and configuration data in the internal memory are not lost.

Recording time

The maximum recording time depends on a number of factors, in particular on the set memory cycle. The values specified in the table (entries in the event list reduce the maximum recording time) apply when one group is activated with 6 analog channels in standard operation and storage of the average values (not the minimum/maximum values).

Memory cycle	Max. recording time
125 ms	Approx. 2 months
1 s	Approx. 11 months
5 s	Approx. 55 months
10 s	Approx. 110 months
60 s	Approx. 662 months

Reports

For each channel in a group, reports can be maintained over specified time periods (maximum, minimum, and average values). Configuration takes place for each group.

Batch report

A batch report can be created for a system using the paperless recorder. The measurement data, the start, end, and duration of the batch can be displayed together with a batch counter and freely definable text on the paperless recorder and in the PC Evaluation Software PCA3000. A barcode scanner can also be used to start and stop the batch and to read batch texts.

Operating modes

The paperless recorder can work in three different operating modes. The memory cycle and memory value can be separately configured for each operating mode.

The operating modes have different priorities:

Event operation

Event operation is activated/deactivated by a control signal (such as a digital input, group, or collective alarm). The device is in event operation for as long as the control signal is active. Event operation has the highest priority.

Time operation

The time operation is active on a daily basis within a programmable timeframe, providing event operation is not active.

Standard operation

If the device is **not** in event or time operation, standard operation is active.

Limit value monitoring

Up to 6 analog values can be monitored by the configurable limit value monitoring. If deviation above or below the limit value is detected, an alarm signal is generated that can be used for individual purposes (such as switching the operating mode from standard to event operation).

Alarm delay can be used to hide short-term transgressions of the limit value so that no alarm signal is issued. It is also possible to suppress the alarm signal by a digital signal.

Counters/integrators

Six additional internal channels are available as counters, integrators, operating time counters, or to determine the total flow volume. A high-speed counter (up to 12.5 kHz) can be implemented via the optional digital input 1.

The counters are actuated via digital signals (counting pulses), whereas the integrators are actuated via analog signals (values are integrated according to the selected time base). Operating time counters determine the timeframe during which a digital signal is active.

The value of the counter/integrator is displayed in a separate window on the paperless recorder in numerical format with a maximum of nine digits (in the event of overflow, the counter restarts with 0). Different recording periods can be set. A minimum and maximum alarm can be configured for each counter/integrator.

Math and logic module

The math and logic module (each with six channels) is available as extra code.

The math function can be used to link various analog and Boolean input variables via a formula that can be freely defined in accordance with mathematical rules (formula with a maximum of 160 ASCII characters). The output variables are real values. As an alternative to entering a formula, the following mathematical functions are already available: difference, ratio, humidity, and floating average.

The logic function allows various Boolean values to be linked via a logic formula (maximum of 600 ASCII characters). The output variables are Boolean values.

The math and logic module can only be configured via the setup program.

Visualization on the device

Various display types are available to visualize the measurement data on the paperless recorder. The visualization screen that appears after a power-on reset can be selected in the configuration, as can the screen that appears when the Home button is pressed.

The colors of the individual channels and the background colour of the analog curves and the digital tracks can be set.

Vertical diagram

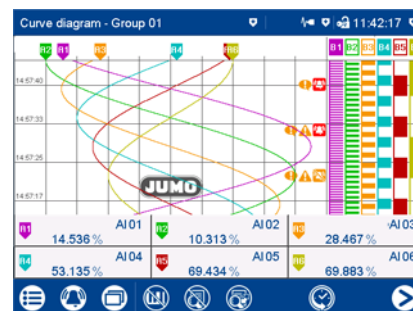

- Analog curves and digital tracks running from top to bottom
- Up to 6 analog and 6 digital channels in one group can be shown on one screen
- Group rotation
- Digital tracks can be hidden
- Information about the channel (short description of signal, analog value) can be hidden

Horizontal diagram

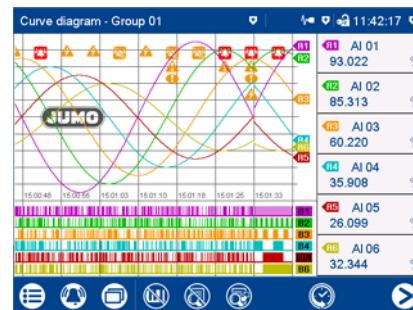

- Analog curves and digital tracks running from right to left
- Digital tracks and channel information can be hidden

Digital diagram

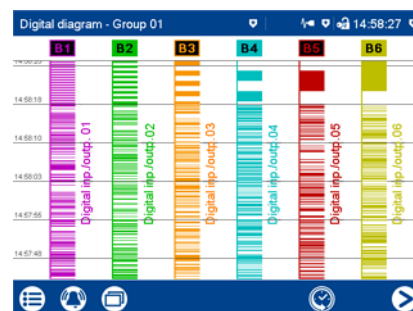

- Up to 6 digital channels in one group on one screen
- Vertical display (digital tracks running from top to bottom)
- Horizontal display (digital tracks running from right to left)



Bar graph display

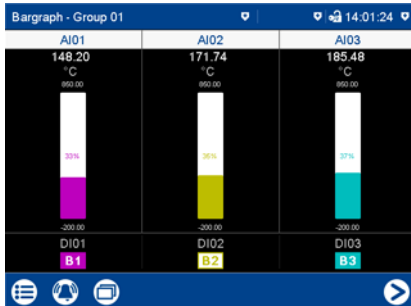

- Up to 6 analog channels in one group as a bar graph on one screen
- Display of scaling and limit values
- Configurable bar color and background color
- Additional display of up to 6 digital channels in one group as a symbol B1 to B6

Text image

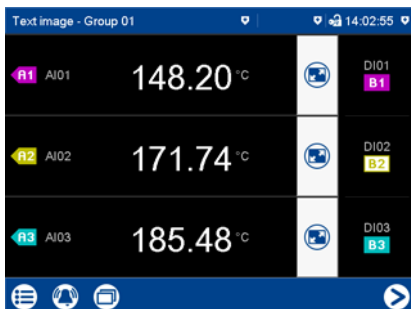

- Numerical display of the measured values from up to 6 analog channels in one group
- Additional display of up to 6 digital channels in one group as a symbol B1 to B6
- Analog channels can be displayed individually

Text image – single view

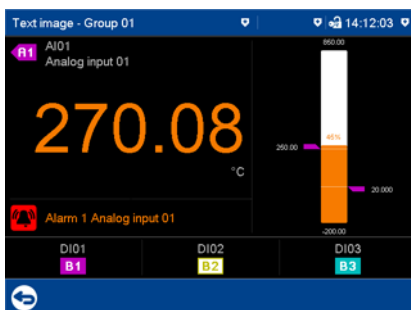

- Analog signal additionally as a bar graph with limit values
- Color change in case of an alarm
- Display of alarm text

Report

External	Current °C	Completed °C
AI01	216.44	209.71
Time	08/19/2015 14:21:43	08/19/2015 14:21:34
Minimum value	176.60	51.169
Time	08/19/2015 14:21:50	08/19/2015 14:21:19
Average value	189.64	93.478
Timestamp start	08/19/2015 14:21:38	08/19/2015 14:21:09
Timestamp end	08/19/2015 14:21:51	08/19/2015 14:21:38

- Display of minimum, maximum, and average value of each analog channel in a group
- Various reporting periods
- Separate report for each group
- Display of the current and the completed report

Batch report

Field	Value
Product name	Sprocket 18SP2
Customer no.	23565
Order no.	0100012455
Employee	John Miller
Batch number	0000000024
Batch start	08/19/2015 15:01:56
Batch end	08/19/2015 15:02:59
Batch duration	01:04

- Logging of a batch record
- Display of the completed batch as a report or curve diagram

Counter/integrator

External	Completed
7000.0	2000.0
Start time: 08/19/2015 14:37:50	Start time: 08/19/2015 14:35:56
Stop time: 08/19/2015 14:38:26	Stop time: 08/19/2015 14:37:45

- Display of the current and the completed counter/integrator
- Status of the counter/integrator with start and stop time
- Current status displayed as a bar graph with limit values

Process screen

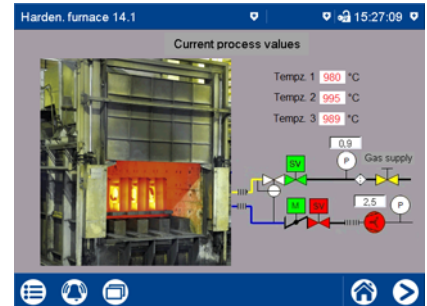

- Display of process data (analog and digital signals) and text
- Up to 6 process screens each with 100 objects
- Library with pictograms (also possible to import own images)
- Individual configuration using the setup program

Web server

The paperless recorder is equipped with a web server function as standard.



The webserver allows the user to display certain settings, process values, and messages using a web browser:

- Parameters of the user level
- Default visualizations
- Individual process screen
- Data of the registry function (including history)
- Alarm and event list

The display depends on the web browser used and the PC operating system.

JUMO GmbH & Co. KG
 Delivery address: Mackenrodtstraße 14
 36039 Fulda, Germany
 Postal address: 36035 Fulda, Germany
 Phone: +49 661 6003-0
 Fax: +49 661 6003-607
 Email: mail@jumo.net
 Internet: www.jumo.net

JUMO Instrument Co. Ltd.
 JUMO House
 Temple Bank, Riverway
 Harlow, Essex CM 20 2DY, UK
 Phone: +44 1279 63 55 33
 Fax: +44 1279 62 50 29
 Email: sales@jumo.co.uk
 Internet: www.jumo.co.uk

JUMO Process Control, Inc.
 6733 Myers Road
 East Syracuse, NY 13057, USA
 Phone: +1 315 437 5866
 Fax: +1 315 437 5860
 Email: info.us@jumo.net
 Internet: www.jumousa.com



PC programs

PCA Communication Software PCC

The PCA Communication Software PCC is a PC program for Windows operating systems (7/8/10 – 32/64 Bit) to read out data from the paperless recorder.

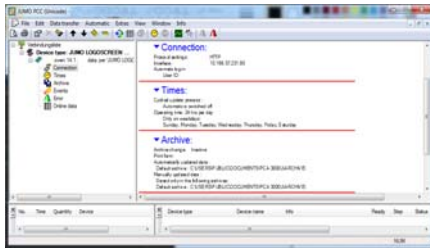

- The data can be read out by means of a USB memory stick or via interface (USB device, Ethernet).
- The data can be read out manually or automatically (for example, every day at 11 pm).

PC Evaluation Software PCA3000

The PC Evaluation Software PCA3000 is a PC program for Windows operating systems (7/8/10 – 32/64 Bit) for managing, archiving, visualizing, and evaluating the data from the paperless recorder.

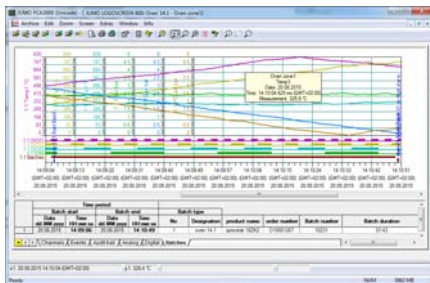

- The data from differently configured devices is detected by the PC Evaluation Software and stored in an archive database. Management is performed fully automatically. All the user has to do is manually enter an ID (additional description).
- The user can access certain data records at any time, which are recognizable by the ID. The time ranges to be evaluated can also be restricted.
- Any analog and digital channels of a paperless recorder (even from different groups) can be subsequently combined in so-called PCA Groups in PCA3000.
- Since each group is shown in its own window, several groups can be displayed on the screen in parallel and compared.
- Using the export filter, it is possible to export the stored data in order to process it in other programs, such as Excel.
- The PC Evaluation Software PCA3000 is network compatible, which means that several users can read the data from the same

archived file (*.177) in a network directory independently of one another.

- With the PCA3000 option "automatic print-out", in conjunction with PCC software, batch data or reports can be printed automatically on a printer or can be supplied as a PDF file within the network. The output forms used are customizable.

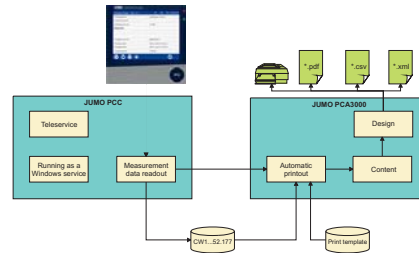

JUMO GmbH & Co. KG
 Delivery address: Mackenrodtstraße 14
 36039 Fulda, Germany
 Postal address: 36035 Fulda, Germany
 Phone: +49 661 6003-0
 Fax: +49 661 6003-607
 Email: mail@jumo.net
 Internet: www.jumo.net

JUMO Instrument Co. Ltd.
 JUMO House
 Temple Bank, Riverway
 Harlow, Essex CM 20 2DY, UK
 Phone: +44 1279 63 55 33
 Fax: +44 1279 62 50 29
 Email: sales@jumo.co.uk
 Internet: www.jumo.co.uk

JUMO Process Control, Inc.
 6733 Myers Road
 East Syracuse, NY 13057, USA
 Phone: +1 315 437 5866
 Fax: +1 315 437 5860
 Email: info.us@jumo.net
 Internet: www.jumousa.com



Technical data

Analog inputs (options 1 and 2)

General information

Quantity	0, 3, or 6
Connector number (back of device)	7 to 9, 11 to 13

Thermocouples

Description	Type	Standard	ITS	Measuring range	Accuracy ^a
Fe-CuNi	"L"	DIN 43710	ITPS-68	-200 to +900 °C	≤ 0.25 %
Fe-CuNi	"J"	IEC 60584-1	ITS-90	-210 to +1200 °C	≤ 0.25 % from -100 °C
Cu-CuNi	"U"	DIN 43710	ITPS-68	-200 to +600 °C	≤ 0.25 % from -100 °C
Cu-CuNi DIN	"T"	IEC 60584-1	ITS-90	-270 to +400 °C	≤ 0.25 % from -150 °C
NiCr-Ni DIN	"K"	IEC 60584-1	ITS-90	-270 to +1372 °C	≤ 0.25 % from -80 °C
NiCr-CuNi	"E"	IEC 60584-1	ITS-90	-270 to +1000 °C	≤ 0.25 % from -80 °C
NiCrSi-NiSi	"N"	IEC 60584-1	ITS-90	-270 to +1300 °C	≤ 0.25 % from -80 °C
Pt10Rh-Pt	"S"	IEC 60584-1	ITS-90	-50 to 1768 °C	≤ 0.25 % from 20 °C
Pt13Rh-Pt	"R"	IEC 60584-1	ITS-90	-50 to 1768 °C	≤ 0.25 % from 50 °C
Pt30Rh-Pt6Rh	"B"	IEC 60584-1	ITS-90	0 to 1820 °C	≤ 0.25 % from 400 °C
W5Re/W26Re	"C"	ASTM E230M-11	ITS-90	0 to 2315 °C	≤ 0.25 % from 500 °C
W3Re/W25Re	"D"	ASTM E1751M-09	ITS-90	0 to 2315 °C	≤ 0.25 % from 500 °C
W5Re/W20Re	"A1"	GOST R 8.585-2001	ITS-90	0 to 2500 °C	≤ 0.25 % from 500 °C
Chromel-Copel	"L"	GOST R 8.585-2001	ITS-90	-200 to +800 °C	≤ 0.25 % from -80 °C
Chromel-Alumel		GOST R 8.585-2001	ITS-90	-270 to 1372 °C	≤ 0.25 % from -80 °C

Ambient temperature influence	≤ 100 ppm/K
Smallest measuring span	Type L (Fe-CuNi), J, U, T, K, E, N, Chromel-Alumel: 100 K Type S, R, B, C, D, A1, Chromel-Copel: 500 K
Measuring range start/end	Freely programmable within the limits in steps of 0.1 K
Cold junction	Internal (Pt100) or external (constant)
Reference point accuracy (internal)	± 1 K
Reference point temperature (external)	-30 to +85 °C (adjustable)
Sampling rate	3 or 6 channels: 125 ms
Input filter	Digital filter, 2nd order; filter constant can be set from 0 to 100.0 s
Galvanic isolation	See "Galvanic isolation"
Base measuring range	20 to 70 mV

^a The accuracy value refers to the maximum measuring range. Small measuring ranges lead to reduced linearization accuracy.

JUMO GmbH & Co. KG
 Delivery address: Mackenrodtstraße 14
 36039 Fulda, Germany
 Postal address: 36035 Fulda, Germany
 Phone: +49 661 6003-0
 Fax: +49 661 6003-607
 Email: mail@jumo.net
 Internet: www.jumo.net

JUMO Instrument Co. Ltd.
 JUMO House
 Temple Bank, Riverway
 Harlow, Essex CM 20 2DY, UK
 Phone: +44 1279 63 55 33
 Fax: +44 1279 62 50 29
 Email: sales@jumo.co.uk
 Internet: www.jumo.co.uk

JUMO Process Control, Inc.
 6733 Myers Road
 East Syracuse, NY 13057, USA
 Phone: +1 315 437 5866
 Fax: +1 315 437 5860
 Email: info.us@jumo.net
 Internet: www.jumousa.com



RTD temperature probe

Description	Standard	ITS	Connection type	Measuring range	Accuracy ^a	Measuring current
Pt50	IEC 751: 2008	ITS-90	2-/3-/4-wire	-200 to +850 °C	≤ 0.1 %	500 µA
Pt100	IEC 751: 2008	ITS-90	2-/3-/4-wire	-200 to +850 °C	≤ 0.1 %	500 µA
Pt500	IEC 751: 2008	ITS-90	2-/3-/4-wire	-200 to +850 °C	≤ 0.1 %	100 µA
Pt1000	IEC 751: 2008	ITS-90	2-/3-/4-wire	-200 to +850 °C	≤ 0.1 %	100 µA
Pt100	JIS 1604		2-/3-/4-wire	-200 to +650 °C	≤ 0.1 %	500 µA
Pt50	GOST 6651-2009 A.2	ITS-90	2-/3-/4-wire	-200 to +850 °C	≤ 0.1 %	500 µA
Pt100	GOST 6651-2009 A.2	ITS-90	2-/3-/4-wire	-200 to +850 °C	≤ 0.1 %	500 µA
Cu50	GOST 6651-2009 A.3	ITS-90	2-/3-/4-wire	-180 to +200 °C	≤ 0.4 %	500 µA
Cu100	GOST 6651-2009 A.3	ITS-90	2-/3-/4-wire	-180 to +200 °C	≤ 0.4 %	500 µA
Ni100	DIN 43760	ITPS-68	2-/3-/4-wire	-60 to +250 °C	≤ 0.2 %	500 µA
Ni100	GOST 6651-2009 A.5	ITPS-68	2-/3-/4-wire	-60 to +180 °C	≤ 0.2 %	500 µA
Ambient temperature influence		≤ 50 ppm/K				
Smallest measuring span		15 K				
Sensor lead wire resistance		Max. 10 Ω per lead for two-wire circuit Max. 30 Ω per lead for three/four-wire circuit				
Measuring range start/end		Freely programmable within the limits in steps of 0.1 K				
Sampling rate		3 or 6 channels: 125 ms				
Input filter		Digital filter, 2nd order; filter constant can be set from 0 to 100.0 s				
Galvanic isolation		See "Galvanic isolation"				

^a The accuracy value refers to the maximum measuring range. Small measuring ranges lead to reduced linearization accuracy.

Resistance transmitter and resistor/potentiometer

Description	Measuring range	Accuracy ^a	Measuring current
Resistance transmitter	0 to 4000 Ω	≤ 0.1 %	100 µA
Resistance/potentiometer	0 to 400 Ω	≤ 0.1 %	500 µA
	0 to 4000 Ω	≤ 0.1 %	100 µA
Ambient temperature influence		≤ 100 ppm/K	
Connection type		Resistance transmitter: Three-wire circuit Resistance/potentiometer: Two/three/four-wire circuit	
Smallest measuring span		60 Ω	
Sensor lead wire resistance		Max. 10 Ω per cable for two-wire and three-wire circuits	
Resistance values		Freely programmable within the limits in steps of 0.1 Ω	
Sampling rate		3 or 6 channels: 125 ms	
Input filter		Digital filter, 2nd order; filter constant can be set from 0 to 100.0 s	
Galvanic isolation		See "Galvanic isolation"	

^a The linearization accuracy value refers to the maximum measuring range. Small measuring ranges lead to reduced linearization accuracy.

JUMO GmbH & Co. KG
 Delivery address: Mackenrodtstraße 14
 36039 Fulda, Germany
 Postal address: 36035 Fulda, Germany
 Phone: +49 661 6003-0
 Fax: +49 661 6003-607
 Email: mail@jumo.net
 Internet: www.jumo.net

JUMO Instrument Co. Ltd.
 JUMO House
 Temple Bank, Riverway
 Harlow, Essex CM 20 2DY, UK
 Phone: +44 1279 63 55 33
 Fax: +44 1279 62 50 29
 Email: sales@jumo.co.uk
 Internet: www.jumo.co.uk

JUMO Process Control, Inc.
 6733 Myers Road
 East Syracuse, NY 13057, USA
 Phone: +1 315 437 5866
 Fax: +1 315 437 5860
 Email: info.us@jumo.net
 Internet: www.jumousa.com



Voltage, current (standard signals)

Description	Measuring range	Accuracy ^a	Input resistance or burden voltage
Voltage	0 to 70 mV	≤ 0.1 %	> 500 kΩ
	0 to 10 V	≤ 0.05 %	> 500 kΩ
	-10 to +10 V	≤ 0.05 %	> 500 kΩ
	-1 to +1 V	≤ 0.08 %	> 500 kΩ
	0 to 1 V	≤ 0.08 %	> 500 kΩ
Current	4 to 20 mA	≤ 0.1 %	< 2 V
	0 to 20 mA	≤ 0.1 %	< 2 V
Ambient temperature influence	≤ 100 ppm/K		
Smallest measuring span			
Voltage	5 mV		
Current	0.5 mA		
Measuring range start/end			
Voltage	Freely programmable within the limits in steps of 0.01 mV		
Current	Freely programmable within the limits in steps of 0.01 mA		
Deviation below/above the measuring range	According to NAMUR recommendation NE 43 (only current input 4 to 20 mA)		
Sampling rate	3 or 6 channels: 125 ms		
Input filter	Digital filter, 2nd order; filter constant can be set from 0 to 100.0 s		
Galvanic isolation	See "Galvanic isolation"		

^a The accuracy value refers to the maximum measuring range. Small measuring ranges lead to reduced linearization accuracy.

Measuring circuit monitoring

The device response in the event of a fault is configurable.

Measuring probe	Probe break	Short-circuit	Polarity
Thermocouple	is detected	is not detected	is detected in certain conditions ^a
RTD temperature probe	is detected	is detected	is not detected
Resistance transmitter	is detected	is not detected	is not detected
Resistance/potentiometer	is detected	is not detected	is not detected
Voltage 0 to 70 mV	is detected	is not detected	is detected
Voltage 0 to 10 V	is not detected	is not detected	is detected
Voltage -10 to +10 V	is not detected	is not detected	is not detected
Voltage 0 to 1 V	is detected	is not detected	is detected
Voltage -1 to +1 V	is detected	is not detected	is not detected
Current 0 to 20 mA	is not detected	is not detected	is not detected
Current 4 to 20 mA	is detected	is detected	is detected

^a dependent on the set characteristic line

JUMO GmbH & Co. KG
 Delivery address: Mackenrodtstraße 14
 36039 Fulda, Germany
 Postal address: 36035 Fulda, Germany
 Phone: +49 661 6003-0
 Fax: +49 661 6003-607
 Email: mail@jumo.net
 Internet: www.jumo.net

JUMO Instrument Co. Ltd.
 JUMO House
 Temple Bank, Riverway
 Harlow, Essex CM 20 2DY, UK
 Phone: +44 1279 63 55 33
 Fax: +44 1279 62 50 29
 Email: sales@jumo.co.uk
 Internet: www.jumo.co.uk

JUMO Process Control, Inc.
 6733 Myers Road
 East Syracuse, NY 13057, USA
 Phone: +1 315 437 5866
 Fax: +1 315 437 5860
 Email: info.us@jumo.net
 Internet: www.jumousa.com



Digital inputs (options 1 and 2)

Quantity	0, 6, or 12
Connector number (back of device)	6 and 10
Input	
Level	Logic level "0": < 3.5 V; logic level "1": > 10 V
Sampling rate	125 ms (max. counting frequency: 8 Hz)
Potential-free contact	R _{ON} : < 1 kΩ; R _{OFF} : > 50 kΩ (use of the auxiliary voltage 24 V)
Auxiliary voltage	DC 24 V +10/-15 %, max. 50 mA per option

Digital inputs/outputs (option 3)

Quantity	0 or 12
Connector number (back of device)	14 and 15
Input or output	Individually configurable as input or output
Input	
Level	Logic level "0": < 3.5 V; logic level "1": > 10 V
Sampling rate	125 ms (max. counting frequency: 8 Hz)
Potential-free contact	R _{ON} : < 1 kΩ; R _{OFF} : > 50 kΩ (use of the auxiliary voltage 24 V)
High-speed input	Input 1
Function	Counts each positive edge of the input signal
Max. counting frequency	12.5 kHz
Mark-to-space ratio	30 to 70 % (high-pulse ≥ 30 μs, low-pulse ≥ 30 μs)
Accuracy in flow measurement	0.5 % of measured value; ambient temperature influence: 50 ppm/K
Output	
Output signal	DC 0/24 V +10/-15 %; galvanically isolated
Current	Max. 40 mA per output, max. 100 mA on the whole
Auxiliary voltage	DC 24 V +10/-15 %, max. 100 mA (incl. current of digital outputs)

Analog outputs (options 1 and 2)

Quantity	0, 1, or 2
Connector number (back of device)	6 and 10
Voltage	
Output signal	DC 0 to 10 V
Load resistance	> 500 Ω
Current	
Output signal	DC 0(4) to 20 mA
Load resistance	< 450 Ω
Accuracy	0.5 %
Ambient temperature influence	150 ppm/K

Relay

Quantity	1
Connector number (back of device)	4
Relay (changeover contact)	
Switching capacity	3 A at AC 230 V, resistive load
Contact life	30,000 switching operations at rated load

JUMO GmbH & Co. KG
 Delivery address: Mackenrodtstraße 14
 36039 Fulda, Germany
 Postal address: 36035 Fulda, Germany
 Phone: +49 661 6003-0
 Fax: +49 661 6003-607
 Email: mail@jumo.net
 Internet: www.jumo.net

JUMO Instrument Co. Ltd.
 JUMO House
 Temple Bank, Riverway
 Harlow, Essex CM 20 2DY, UK
 Phone: +44 1279 63 55 33
 Fax: +44 1279 62 50 29
 Email: sales@jumo.co.uk
 Internet: www.jumo.co.uk

JUMO Process Control, Inc.
 6733 Myers Road
 East Syracuse, NY 13057, USA
 Phone: +1 315 437 5866
 Fax: +1 315 437 5860
 Email: info.us@jumo.net
 Internet: www.jumousa.com



Interfaces

RS232/RS485	Quantity Connector type Baud rate Data format Protocol Application External inputs	1 (can be switched between RS232 and RS485) SUB-D 9-pin (socket) 9600, 19200, 38400, 115200 8/1n, 8/1e, 8/1o Modbus RTU as master or slave; barcode scanner Communication with Modbus master/slave, connection of a barcode scanner Via Modbus master/slave functionality: 24 analog and 24 digital inputs, 10 batch texts, 4 event texts
Ethernet	Quantity Connector type Transfer rate Protocol Application External inputs Max. cable length	1 RJ45 (socket) 10 Mbit/s, 100 Mbit/s IPv4; TCP, UDP; DHCP, DNS, HTTP, SMTP, SNMP, Modbus/TCP Communication with PC (setup program, data archiving, web server), email server, SNMP server, and Modbus master/slave Via Modbus master/slave functionality: 24 analog and 24 digital inputs, 10 batch texts, 4 event texts 100 m
USB host	Quantity Connector type Standard Application Max. load current	1 (on front with cover) A (socket) USB 2.0 (high speed) Exclusively for connecting a USB flash drive (FAT16/FAT32; see accessories) 100 mA
USB device	Quantity Connector type Standard Application Max. cable length	1 (on the back) Micro-B (socket) USB 2.0 (high speed) To connect to a PC (setup program, PCC/PCA3000) 5 m

Screen

Type	TFT color screen/touchscreen (resistive) ^a
Size	14.5 cm (5.7")
Resolution	640 × 480 pixels (VGA)
Number of colors	65536
Frame rate	60 Hz (type)
Brightness setting	Adjustable on the device
Screen saver (switch-off)	After waiting period or control signal

^a TFT color screens can have pixel errors due to technological and/or production-related reasons. Four pixel errors are deemed acceptable for this paperless recorder. They do not constitute an assertion for warranty claims.

JUMO GmbH & Co. KG
 Delivery address: Mackenrodtstraße 14
 36039 Fulda, Germany
 Postal address: 36035 Fulda, Germany
 Phone: +49 661 6003-0
 Fax: +49 661 6003-607
 Email: mail@jumo.net
 Internet: www.jumo.net

JUMO Instrument Co. Ltd.
 JUMO House
 Temple Bank, Riverway
 Harlow, Essex CM 20 2DY, UK
 Phone: +44 1279 63 55 33
 Fax: +44 1279 62 50 29
 Email: sales@jumo.co.uk
 Internet: www.jumo.co.uk

JUMO Process Control, Inc.
 6733 Myers Road
 East Syracuse, NY 13057, USA
 Phone: +1 315 437 5866
 Fax: +1 315 437 5860
 Email: info.us@jumo.net
 Internet: www.jumousa.com



Electrical data

Voltage supply	AC 110 to 240 V +10/-15 %, 48 to 63 Hz or AC/DC 20 to 30 V, 48 to 63 Hz
Electrical safety	According to DIN EN 61010-1 Overvoltage category II up to 300 V mains voltage, pollution degree 2
Protection rating	I with internal isolation from SELV
Power consumption AC 110 to 240 V AC/DC 20 to 30 V	< 45 VA < 30 VA
Data backup	Internal flash memory
Data buffering	Battery (operating life > 7 years); additionally, storage capacitor for buffering during battery change (buffer time approx. 6 minutes)
Clock	Battery-buffered real-time clock
Electrical connection	On the back via push-in spring-cage terminals
Conductor cross section Wire or strand without ferrule Strand with ferrule 2 × strand with twin ferrule with plastic collar Stripping length	At plug connector 4 and 5 (voltage supply and relay) Min. 0.2 mm ² , max. 2.5 mm ² Min. 0.25 mm ² , max. 2.5 mm ² Min. 0.5 mm ² , max. 1.5 mm ² (both strands with identical cross section) 10 mm
Conductor cross section Wire or strand without ferrule Strand with ferrule Stripping length	At plug connector 6 to 15 (inputs and outputs) Min. 0.14 mm ² , max. 1.5 mm ² Without plastic collar: min. 0.25 mm ² , max. 1.5 mm ² With plastic collar: min. 0.25 mm ² , max. 0.5 mm ² 9 mm
Voltage supply influence	< 0.1 % of the measuring range

Environmental influences

Ambient temperature range Storage Operation	-20 to +60 °C 0 to +50 °C
Site altitude	Up to 2000 m above sea level
Climatic environmental conditions Resistance to climatic conditions Storage Operation	According to DIN EN 60721-3 with extended temperature range ≤ 85 % rel. humidity without condensation According to class 1K2 According to class 3K3
Mechanical environmental conditions Storage Transport Operation	According to DIN EN 60721-3 According to class 1M2 According to class 2M2 According to class 3M3
Electromagnetic compatibility (EMC) Interference emission Interference immunity	According to DIN EN 61326-1 Class A – only for industrial use – Industrial requirements

JUMO GmbH & Co. KG
 Delivery address: Mackenrodtstraße 14
 36039 Fulda, Germany
 Postal address: 36035 Fulda, Germany
 Phone: +49 661 6003-0
 Fax: +49 661 6003-607
 Email: mail@jumo.net
 Internet: www.jumo.net

JUMO Instrument Co. Ltd.
 JUMO House
 Temple Bank, Riverway
 Harlow, Essex CM 20 2DY, UK
 Phone: +44 1279 63 55 33
 Fax: +44 1279 62 50 29
 Email: sales@jumo.co.uk
 Internet: www.jumo.co.uk

JUMO Process Control, Inc.
 6733 Myers Road
 East Syracuse, NY 13057, USA
 Phone: +1 315 437 5866
 Fax: +1 315 437 5860
 Email: info.us@jumo.net
 Internet: www.jumousa.com



Case

Case type	Flush-mounted case according to DIN IEC 61554 made of zinc-plated steel sheet (indoor use)
Case front	Made of diecast zinc with decor foil
Front frame dimensions	144 mm x 144 mm (front frame depth approx. 8 mm incl. seal)
Mounting depth	119 mm (incl. spring-cage terminals)
Panel cut-out	138 ^{+1.0} mm x 138 ^{+1.0} mm
Panel thickness	2 to 8 mm
Case fastening	In panel, using the four supplied mounting elements
Operating position	Any, with due consideration for the viewing angle of the screen, horizontal ±50°, vertical ±30°
Protection type	According to DIN EN 60529, IP65 on the front, IP20 on the back
Weight	Max. 1.6 kg

Approvals/approval marks

Approval mark	Testing agency	Certificates/certification numbers	Inspection basis	Valid for
c UL us	Underwriters Laboratories	E201387	UL 61010-1 (3rd Ed.), CAN/CSA-22.2 No. 61010-1 (3rd Ed.)	All types

Dimensions

Device

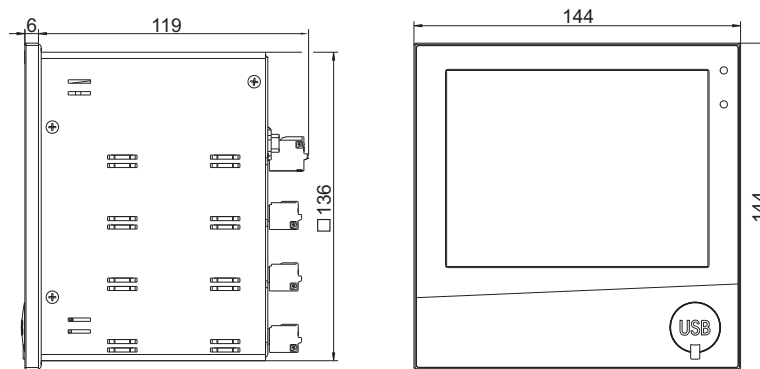

Panel cut-out

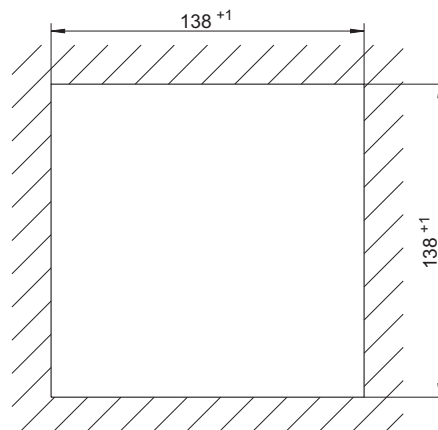

JUMO GmbH & Co. KG
 Delivery address: Mackenrodtstraße 14
 36039 Fulda, Germany
 Postal address: 36035 Fulda, Germany
 Phone: +49 661 6003-0
 Fax: +49 661 6003-607
 Email: mail@jumo.net
 Internet: www.jumo.net

JUMO Instrument Co. Ltd.
 JUMO House
 Temple Bank, Riverway
 Harlow, Essex CM 20 2DY, UK
 Phone: +44 1279 63 55 33
 Fax: +44 1279 62 50 29
 Email: sales@jumo.co.uk
 Internet: www.jumo.co.uk

JUMO Process Control, Inc.
 6733 Myers Road
 East Syracuse, NY 13057, USA
 Phone: +1 315 437 5866
 Fax: +1 315 437 5860
 Email: info.us@jumo.net
 Internet: www.jumousa.com



Side-by-side mounting

Spacing of panel cut-outs	Horizontal	Vertical
Minimum spacing	20 mm	20 mm
Recommended spacing (easier insertion of the mounting elements)	50 mm	50 mm

Galvanic isolation

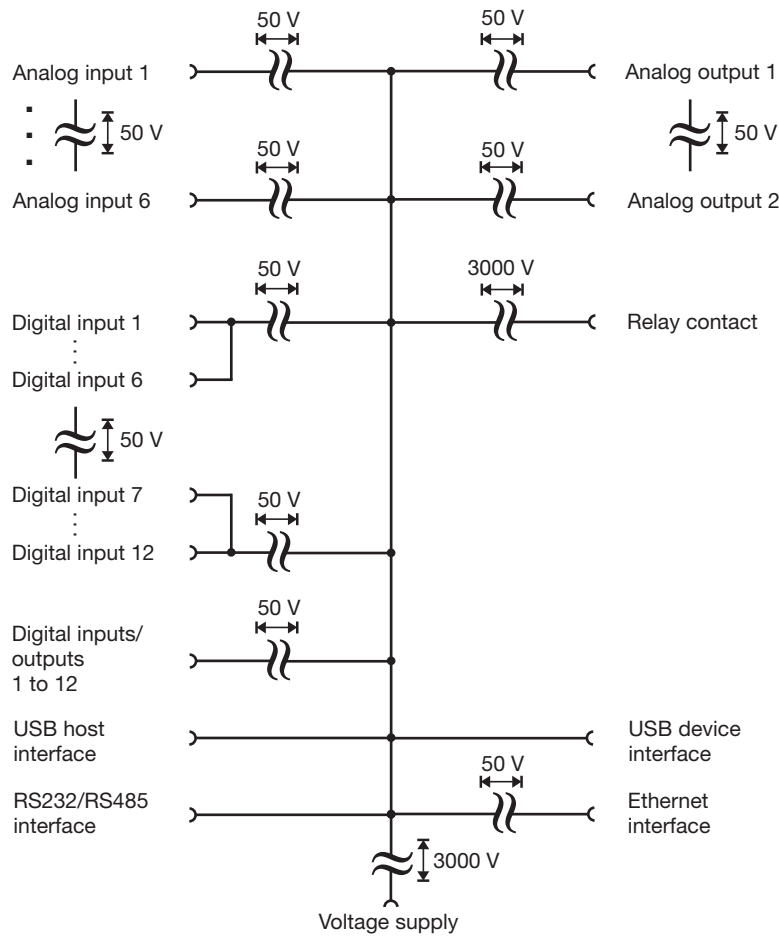



Connection elements

Front USB host interface (without cover)

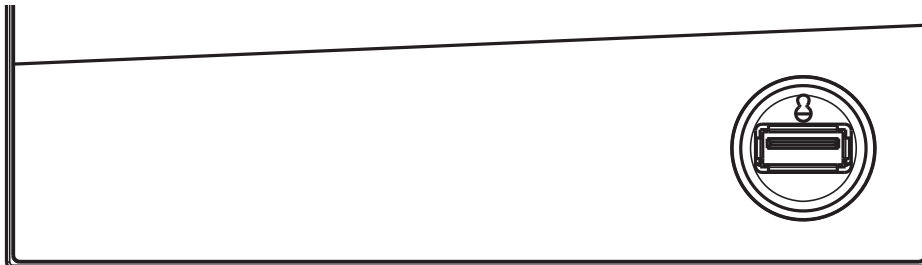

Back connection elements

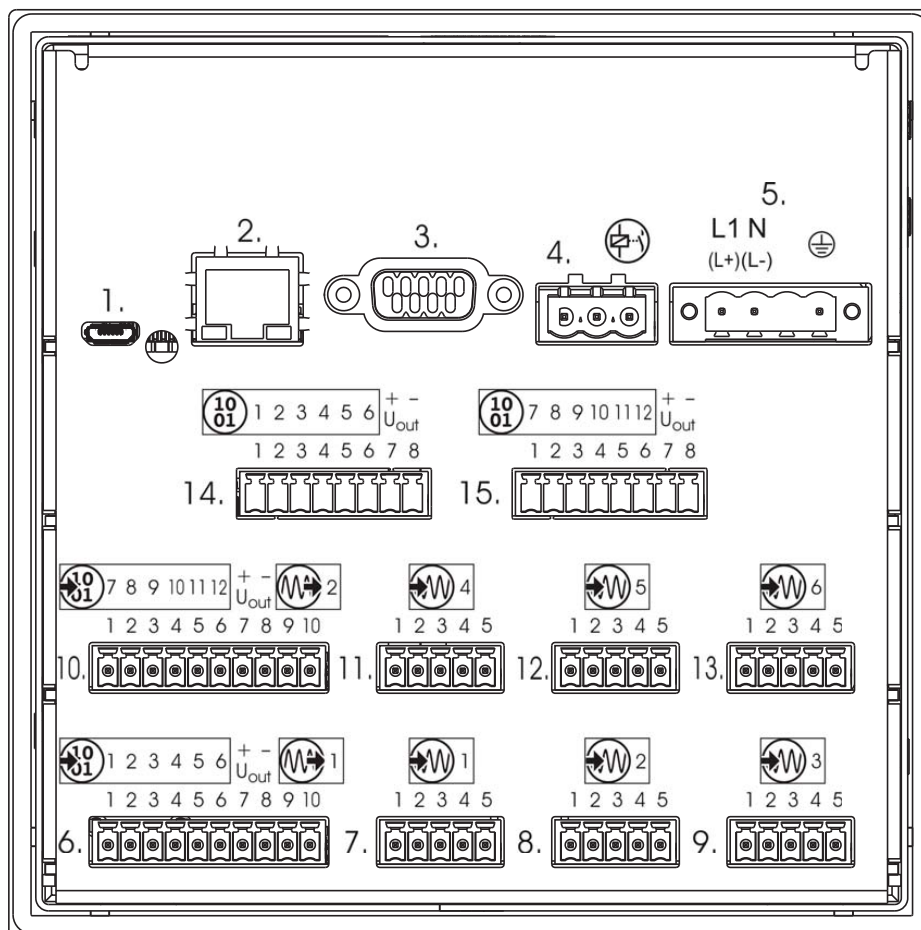

Connection element and assignment

- 1. USB device interface
- 3. RS232/RS485 interface
- 5. Voltage supply
- 7. Analog input 1
- 9. Analog input 3
- 11. Analog input 4
- 13. Analog input 6
- 15. Digital inputs/outputs 7 to 12

Connection element and assignment

- 2. Ethernet interface
- 4. Relay
- 6. Digital inputs 1 to 6, analog output 1
- 8. Analog input 2
- 10. Digital inputs 7 to 12, analog output 2
- 12. Analog input 5
- 14. Digital inputs/outputs 1 to 6

JUMO GmbH & Co. KG
 Delivery address: Mackenrodtstraße 14
 36039 Fulda, Germany
 Postal address: 36035 Fulda, Germany
 Phone: +49 661 6003-0
 Fax: +49 661 6003-607
 Email: mail@jumo.net
 Internet: www.jumo.net

JUMO Instrument Co. Ltd.
 JUMO House
 Temple Bank, Riverway
 Harlow, Essex CM 20 2DY, UK
 Phone: +44 1279 63 55 33
 Fax: +44 1279 62 50 29
 Email: sales@jumo.co.uk
 Internet: www.jumo.co.uk

JUMO Process Control, Inc.
 6733 Myers Road
 East Syracuse, NY 13057, USA
 Phone: +1 315 437 5866
 Fax: +1 315 437 5860
 Email: info.us@jumo.net
 Internet: www.jumousa.com



Connection diagram

The connection diagram included in the data sheet provides initial information about the connection options. Only use the brief instructions or the operating manual for the electrical connection. The know-how and the correct technical implementation of the safety warnings/instructions contained in these documents are the prerequisite for the installation, electrical connection, and initial start as well as for the safety during operation.

Analog inputs 1 to 6 (options 1 and 2)

Measuring probe	Connection element / Assignment	Terminals and connection symbol
Thermocouple	7. / Analog input 1 8. / Analog input 2 9. / Analog input 3 11. / Analog input 4	
RTD temperature probe two-wire circuit	12. / Analog input 5 13. / Analog input 6	
RTD temperature probe three-wire circuit		
RTD temperature probe four-wire circuit		
Resistance transmitter		
Resistance/potentiometer two-wire circuit		
Resistance/potentiometer three-wire circuit		
Resistance/potentiometer four-wire circuit		
Voltage DC -10(0) to +10 V		

JUMO GmbH & Co. KG
 Delivery address: Mackenrodtstraße 14
 36039 Fulda, Germany
 Postal address: 36035 Fulda, Germany
 Phone: +49 661 6003-0
 Fax: +49 661 6003-607
 Email: mail@jumo.net
 Internet: www.jumo.net

JUMO Instrument Co. Ltd.
 JUMO House
 Temple Bank, Riverway
 Harlow, Essex CM 20 2DY, UK
 Phone: +44 1279 63 55 33
 Fax: +44 1279 62 50 29
 Email: sales@jumo.co.uk
 Internet: www.jumo.co.uk

JUMO Process Control, Inc.
 6733 Myers Road
 East Syracuse, NY 13057, USA
 Phone: +1 315 437 5866
 Fax: +1 315 437 5860
 Email: info.us@jumo.net
 Internet: www.jumousa.com



Measuring probe	Connection element / Assignment	Terminals and connection symbol
Voltage DC -1(0) to +1 V	7. / Analog input 1 8. / Analog input 2 9. / Analog input 3	
Voltage DC 0 to 70 mV	11. / Analog input 4 12. / Analog input 5 13. / Analog input 6	
Current DC 0(4) to 20 mA		

Digital inputs 1 to 12 (options 1 and 2)

Version	Connection element.Terminal / Assignment	Terminals and connection symbol
Digital input DC 0/24 V, auxiliary voltage (output) DC 24 V (50 mA, per option)	6.1 / Digital input 1 6.2 / Digital input 2 6.3 / Digital input 3 6.4 / Digital input 4 6.5 / Digital input 5 6.6 / Digital input 6 6.7 / +24 V 6.8 / GND 10.1 / Digital input 7 10.2 / Digital input 8 10.3 / Digital input 9 10.4 / Digital input 10 10.5 / Digital input 11 10.6 / Digital input 12 10.7 / +24 V 10.8 / GND	<p>Example: potential-free contact at input 1 and +24 V (auxiliary voltage)</p> <p>Example: external voltage at input 1 and GND</p>

Analog outputs 1 and 2 (options 1 and 2)

Version	Connection element.Terminal / Assignment	Terminals and connection symbol
Analog output DC 0 to 10 V or DC 0(4) to 20 mA (configurable)	6.9 / Analog output 1 + 6.10 / Analog output 1 - 10.9 / Analog output 2 + 10.10 / Analog output 2 -	

JUMO GmbH & Co. KG
 Delivery address: Mackenrodtstraße 14
 36039 Fulda, Germany
 Postal address: 36035 Fulda, Germany
 Phone: +49 661 6003-0
 Fax: +49 661 6003-607
 Email: mail@jumo.net
 Internet: www.jumo.net

JUMO Instrument Co. Ltd.
 JUMO House
 Temple Bank, Riverway
 Harlow, Essex CM 20 2DY, UK
 Phone: +44 1279 63 55 33
 Fax: +44 1279 62 50 29
 Email: sales@jumo.co.uk
 Internet: www.jumo.co.uk

JUMO Process Control, Inc.
 6733 Myers Road
 East Syracuse, NY 13057, USA
 Phone: +1 315 437 5866
 Fax: +1 315 437 5860
 Email: info.us@jumo.net
 Internet: www.jumousa.com



Digital inputs/outputs 1 to 12 (option 3)

Version	Connection element.Terminal / Assignment	Terminals and connection symbol
Digital input DC 0/24 V or digital output DC 0/24 V (individually switchable), auxiliary voltage (output) DC 24 V (100 mA, sum of the currents at the terminals 14.7 and 15.7)	14.1 / Digital input/output 1 14.2 / Digital input/output 2 14.3 / Digital input/output 3 14.4 / Digital input/output 4 14.5 / Digital input/output 5 14.6 / Digital input/output 6 14.7 / +24 V 14.8 / GND 15.1 / Digital input/output 7 15.2 / Digital input/output 8 15.3 / Digital input/output 9 15.4 / Digital input/output 10 15.5 / Digital input/output 11 15.6 / Digital input/output 12 15.7 / +24 V 15.8 / GND	<p>Example: potential-free contact at input 1 and +24 V (auxiliary voltage)</p> <p>Example: external voltage at input 1 and GND</p> <p>Example: external relay at output 1 and GND (max. 40 mA per output, max. 100 mA on the whole)</p>
Note: Auxiliary voltage supply and digital outputs deliver together max. 100 mA at 24 V.		

Relay

Version	Connection element.Terminal / Assignment	Terminals and connection symbol
Relay (changeover contact) (max. 3 A at AC 230 V, resistive load)	4.1 / Normally open contact (NO) 4.2 / Joint contact (C) 4.3 / Normally closed contact (NC)	

RS232/RS485 interface

Version	Connection element.Pin / Assignment	Connection element
RS232 9-pin SUB-D socket (switchable to RS485)	3.2 / RxD (received data) 3.3 / TxD (transmission data) 3.5 / GND (ground)	
RS485 9-pin SUB-D-socket (switchable to RS232)	3.3 / TxD+/RxD+ (transmission/received data +) 3.5 / GND (ground) 3.8 / TxD-/RxD- (transmission/received data -)	

Voltage supply

Version	Connection element.Terminal / Assignment	Terminals and connection symbol
AC 110 to 240 V +10/-15 %, 48 to 63 Hz or AC/DC 20 to 30 V, 48 to 63 Hz Observe order details!	5.L1 / Line conductor (for DC: positive terminal L+) 5.N / Neutral conductor (for DC: negative terminal L-) 5.PE / Protection conductor	

JUMO GmbH & Co. KG
 Delivery address: Mackenrodtstraße 14
 36039 Fulda, Germany
 Postal address: 36035 Fulda, Germany
 Phone: +49 661 6003-0
 Fax: +49 661 6003-607
 Email: mail@jumo.net
 Internet: www.jumo.net

JUMO Instrument Co. Ltd.
 JUMO House
 Temple Bank, Riverway
 Harlow, Essex CM 20 2DY, UK
 Phone: +44 1279 63 55 33
 Fax: +44 1279 62 50 29
 Email: sales@jumo.co.uk
 Internet: www.jumo.co.uk

JUMO Process Control, Inc.
 6733 Myers Road
 East Syracuse, NY 13057, USA
 Phone: +1 315 437 5866
 Fax: +1 315 437 5860
 Email: info.us@jumo.net
 Internet: www.jumousa.com



Order details

(1) Basic type	
706520	Paperless recorder with 1x Ethernet, 2x USB (1x host, 1x device), and 1x RS232/485 interface and one relay
(2) Basic type extension	
0	Without software package
1	With software package (setup program incl. USB cable, PC Evaluation Software PCA3000, PCA Communication Software PCC)
(3) Language	
8	Set per default (German/English)
9	Set according to customer specifications
(4) Option 1 (expansion slot 1)^a	
0	Not used
1	3 analog and 6 digital inputs, 1 analog output
(5) Option 2 (expansion slot 2)^a	
0	Not used
1	3 analog and 6 digital inputs, 1 analog output
(6) Option 3 (expansion slot 3)^a	
0	Not used
1	12 digital inputs/outputs (independently configurable as input or output)
(7) Voltage supply	
23	AC 110 to 240 V +10/-15 %, 48 to 63 Hz
25	AC/DC 20 to 30 V, 48 to 63 Hz
(8) Extra code	
.	Not used
260	Math and logic module (6 channels each)

^a Subsequent expansion is only possible in JUMO Central Services.

Order code (1) (2) (3) (4) (5) (6) (7) (8)
 [] / [] [] [] - [] [] [] - [] / []
Order example 706520 / 1 8 - 1 0 0 - 25 / 260

Scope of delivery

1 paperless recorder in the ordered version
1 brief instructions
4 mounting elements
1 CD with detailed operating manual and supplementary documentation

Accessories

Description	Part no.
Setup program	00645110
USB cable, A-plug to micro-B-plug, 3 m	00616250
PC Evaluation Software PCA3000	00431882
PCA Communication Software PCC	00431879
USB memory stick, 2 GB ^a	00505592
Activation for math and logic module (setup program required)	00393217

^a The USB memory stick indicated has been tested and is designed for industrial applications. No liability is assumed for other brands.